

Multimatic® 215 PRO

MIG/Multiprocess Power Source,
Wire Feeder and Gun Package



QUICK SPECS

Light Industrial Applications

Light fabrication
Maintenance and repair
Auto body
Farm/home

Processes

MIG (GMAW)
Pulsed MIG (GMAW-P)*
Flux-cored (FCAW)
DC TIG (GTAW)
Pulsed TIG (GTAW-P)*
DC stick (SMAW)

*240 V only

Weld Thickness

120 V: 24 ga.–3/16 in. steel
18 ga.–1/8 in. aluminum
240 V: 24 ga.–3/8 in. steel
18 ga.–3/8 in. aluminum

Input Power

120 or 240 V, single-phase, 50/60 Hz

Rated Output

120 V: 110 A at 19.5 VDC, 60% duty cycle
240 V: 160 A at 22.0 VDC, 60% duty cycle
215 A at 24.8 VDC, 30% duty cycle

The Multimatic 215 PRO gives you the freedom to weld any process—MIG, flux-cored, DC TIG, and stick—with one portable, powerful, easy-to-use machine.



Now With
Pulse Capabilities

Includes a 15-foot (4.6 m) MDX™-100 MIG gun with front load liner that optimizes wire feedability.

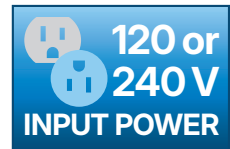

Uses 120- or 240-volt power

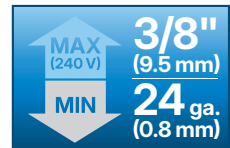

MIG weld capacity



Portable



Quick and easy setup

Comes complete with:

- Power source
- 15 ft. (4.6 m) MDX™-100 MIG gun
- 15 ft. (4.6 m) cable with electrode holder and 25 mm Dinse-style connector
- 15 ft. (4.6 m) work cable with clamp
- 6.5 ft. (2 m) power cord with MVP™ plugs for 120 V and 240 V
- Flow gauge regulator and gas hose for argon or AR/CO₂ mix
- Two contact tips for .035 in. (0.9 mm) wire
- Quick Select™ drive roll for .024 in. (0.6 mm) or .030/.035 in. (0.8/0.9 mm) solid wire, and .030/.035 in. (0.8/0.9 mm) flux-cored wire

- Hook-and-loop cord wraps
- Material thickness gauge ▶ 229895

Note: Shielding gas and safety equipment not included.



TRUE BLUE
3YR. WARRANTY

Welder is warranted for three years, parts and labor.
Gun warranted for 90 days, parts only.



Miller Electric Mfg. LLC
An ITW Welding Company
1635 West Spencer Street
P.O. Box 1079
Appleton, WI 54912-1079 USA

Equipment Sales US and Canada
Phone: 866-931-9730
International Phone: 920-735-4554

MillerWelds.com
f X v i n



Multimatic® 215 PRO Features and Benefits



Take on more projects with one machine that has MIG, DC TIG, and stick.

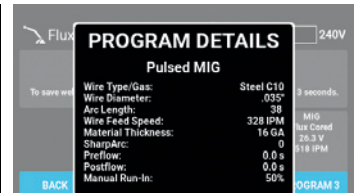
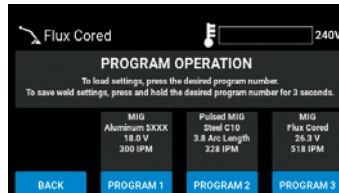

Program mode allows easy save and recall of favorite weld settings.

- Delivers greater productivity by eliminating the need to manually set or change parameters.
- Delivers consistent quality by welders of all skill levels by using prequalified weld settings.

Auto-Set™ fast and easy predefined settings for multiple materials and processes to help you get welding quickly. Available for all processes.

Smooth-Start™ provides a smooth, spatter-free start. It's the best-starting machine in the small multiprocess machine category.

Dyna-Pulse™. Dynamic pulse delivers higher quality MIG welds with exceptional arc control and versatility.

- Fewer machine adjustments when transitioning between positions, joints, and wire types.
- Lower heat input for less distortion on thin materials and better puddle control on out-of-position welds.
- Minimized spatter reduces post-weld grinding and rework.
- Ideal for MIG welding applications where control and appearance matter most.

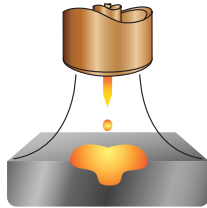

BeadVision™ provides graphic feedback as parameters are adjusted. Users will be able to see how setting changes affect penetration and bead profile.

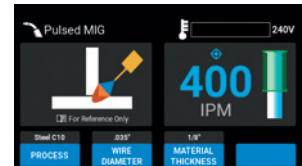

Multi-voltage plug (MVP™) allows connection to common 120- and 240-volt power receptacles without the use of any tools — simply choose the plug that fits the receptacle and connect to the power cord.



Angled cast-aluminum drive system with calibrated tension knob creates consistent feeding and easy setup.

Quick Select™ drive roll makes setup quicker by offering three grooves — two for different size solid wire and a third for flux-cored wire.

Continually upgradeable. USB-upgradeable software allows expandable machine capabilities without requiring mechanical modifications. This ensures your investment continues to produce over time, even as needs evolve.

Auto Spool Gun Detect™ automatically detects when a MIG gun or spool gun is connected, eliminating the need for a switch.

Fan-On-Demand™ cooling system only operates when needed, reducing noise, energy use and contaminants pulled through the machine.

Uses 4- or 8-inch (102 or 203 mm) spools and can be set up to weld with .024–.035 inch (0.6–0.9 mm) solid wire and .030–.045 inch (0.8–1.2 mm) flux-cored wire.

BEST FOR	STANDARD SPRAY	PULSED MIG	SHORT CIRCUIT
Gap filling	D	B	A
Low heat input	D	B	A
Out-of-position welds		A	B
Low spatter	A	A	C
Thick metals	A	A	D
Thin metals		B	A
Increased travel speed	A	A	B
Aluminum MIG welding	C	A	C



Ratings A, B, C, and D are relative values. An "A" rating indicates a best fit between your performance needs and process. A "blank" rating indicates that the process is not recommended for that application.

Operation Modes

Auto-Set™ mode



Auto-Set eliminates guesswork and saves you time on setup. Begin by pressing the Auto-Set button. The Auto-Set button's back light indicates the mode is activated.

1. Press Auto-Set soft key to open the process selection menu.
Turn either right or left knob to highlight desired process. Press either right or left knob to select process.
2. Repeat for wire diameter, Tungsten size, or electrode diameter depending on selected process.
3. Repeat for material thickness.

Auto-Set allows for adjustments within a predefined window of settings for the welding process. This window is indicated by the green brackets. If you need larger adjustments, press the Auto-Set button again to enter Manual Mode and adjust as needed.

Manual mode



When welding outside of Auto-Set capabilities, or if you prefer custom parameters, use manual mode. To access manual mode, ensure that Auto-Set is off. Simply rotate the left and right knobs to adjust parameters.

Specifications (Subject to change without notice.)



WELDING MODE/ PROCESS	INPUT POWER	AMPERAGE RANGE	RATED OUTPUT	AMPS INPUT AT RATED OUTPUT, 50/60 HZ				WIRE FEED SPEED	MAX. OPEN-CIRCUIT VOLTAGE	DIMENSIONS	NET WEIGHT
				120 V	240 V	KVA	KW				
CV: MIG/ flux-cored	120 V	30–140 A	110 A at 19.5 VDC, 60% duty cycle	21.7	—	2.6	2.6	60–600 ipm (1.5–15.2 m/min.)	57	H: 14.625 in. (372 mm) W: 9.75 in. (248 mm) D: 20 in. (508 mm)	35 lb. (15.9 kg)
	240 V	30–230 A	160 A at 22 VDC, 60% duty cycle	—	17	4.1	4.1				
			215 A at 24.8 VDC, 30% duty cycle	—	25.7	6.2	6.2				
CC: TIG	120 V	20–150 A	140 A at 15.6 VDC, 40% duty cycle	22.7	—	2.8	2.8	—			
	240 V	20–210 A	190 A at 17.6 VDC, 20% duty cycle	—	16.6	4	3.9				
CC: Stick*	120 V	30–100 A	95 A at 23.8 VDC, 40% duty cycle	22.5	—	2.7	2.7				
	240 V	30–200 A	190 A at 27.6 VDC, 20% duty cycle	—	25	6	6				

*Not recommended for 6010 electrodes.



Certified by Canadian Standards Association to both the Canadian and U.S. Standards.

Performance Data

MIG DUTY CYCLE CHART

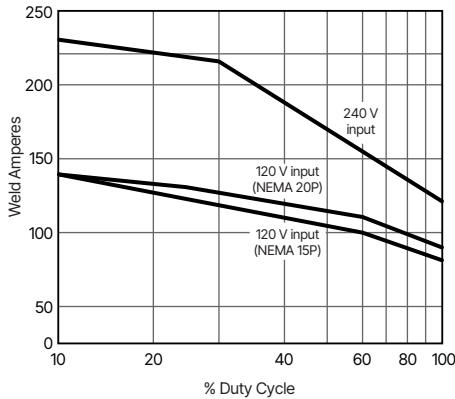

DC TIG DUTY CYCLE CHART

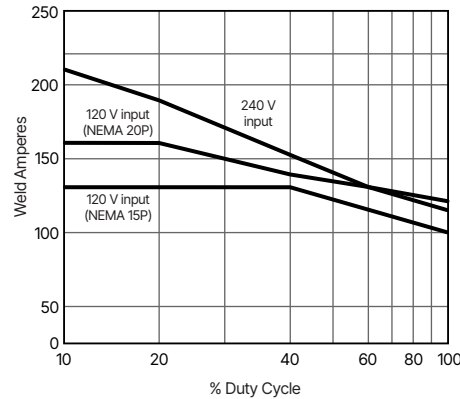

STICK DUTY CYCLE CHART

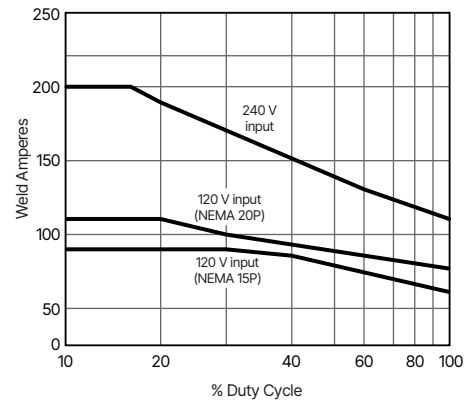

Control Panel

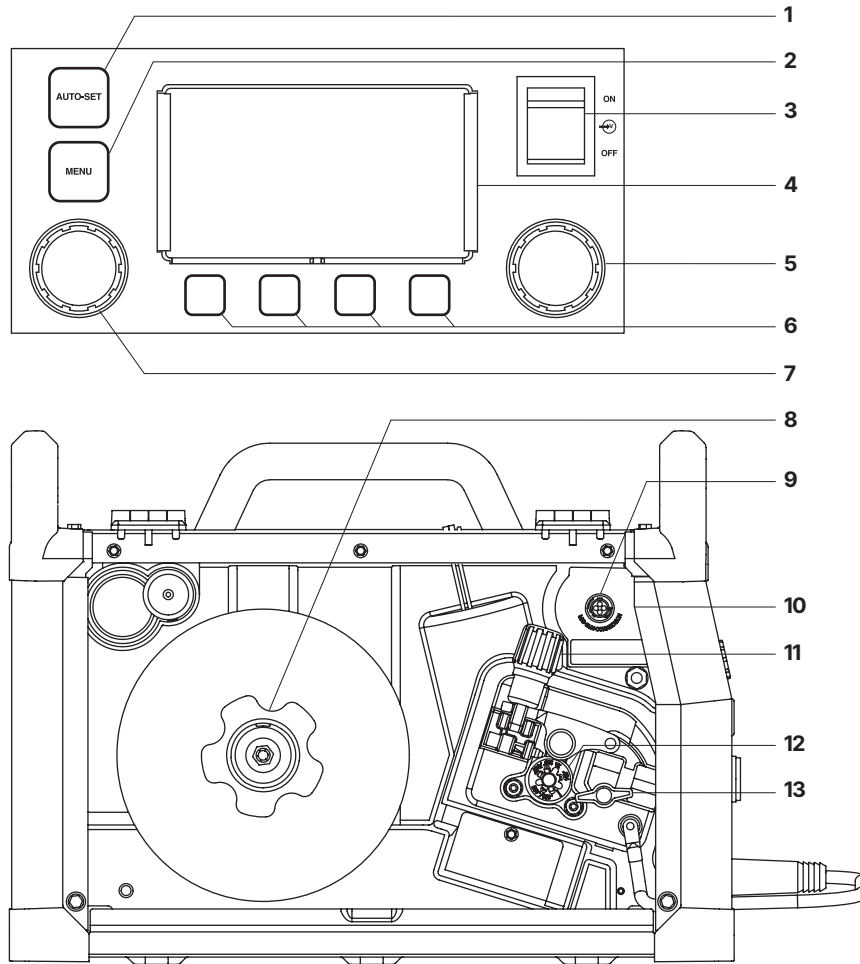

1. Auto-Set Button
2. Menu Button
3. Power On/Off Switch
4. Color LCD Display
5. Right Adjustment Knob
(adjusts wire feed speed or parameter values depending on mode)
6. Soft Keys *(multiple functions depending on screen displayed)*
7. Left Adjustment Knob
(adjusts voltage, arc length or parameter values depending on mode)
8. Plastic Hub with Retaining Ring for 8-inch Spools
(shaft also accepts 4-inch spools)
9. MIG Gun Connection
10. USB Software Port *(inside to the right)*
11. Calibrated Tension Knob
12. Drive Roll
13. T-Knob *(secures torch)*

Genuine Miller® Accessories



MDX™-100 MIG Gun 1770029

15 ft. (4.6 m), 100-amp MIG gun with Miller® MDX MIG consumables for .030–.035 in. (0.8–0.9 mm) wire.

- Install contact tips with a single turn.
- Front load liner locks at front and back of gun to align with contact tip and power pin for a flawless wire feed path.
- Durable, ergonomic handle with overmolding improves grip and comfort.
- Ball-and-socket handle with rear swivel for increased gun maneuverability while reducing welder fatigue.



Spoolmate™ 100 Spool Gun 300371

Direct-connect spool gun handles .030–.035 inch (0.8–0.9 mm) aluminum (4043 only) and .023–.035 inch (0.6–0.9 mm) steel/stainless steel wires. Rated at 135 amps, 30 percent duty cycle. Includes 12-foot (3.7 m) cable assembly and custom carrying case.



Spoolmate™ 150 Spool Gun 301272

Direct-connect spool gun handles .030–.035 inch (0.8–0.9 mm) 4000/5000 series aluminum and .023–.035 inch (0.6–0.9 mm) steel/stainless steel wires. Rated at 150 amps, 60 percent duty cycle. Includes 20-foot (6.1 m) cable assembly.



Kit
301917
shown.

TIG Contractor Kit

301917 With wireless remote foot control

301916 With wired foot control

Kit comes complete with everything needed to TIG weld with the Multimatic® 215 PRO. Includes 12.5-foot (3.8 m) Weldcraft™ A-150 TIG torch with flow thru Dinse-style connector, wireless remote foot pedal **OR** RFCS-14 HD wired foot pedal, flow gauge regulator with 12-foot (3.7 m) gas hose, and AK2C torch accessory kit.



Weldcraft™ A-150 (WP-17) TIG Torch WP1712RDI25

12.5-foot (3.8 m) 150-amp air-cooled torch with 25 mm flow thru Dinse-style connector.



TIG Torch Accessory Kit AK2C

Includes one short back cap, one of each size (#4, #5, #6) alumina nozzle, and one of each size (.040, 1/16, 3/32 inch) of the following: collet, collet body, and 7-inch 2% ceriated tungsten electrode.



Wireless Remote Foot Control 301580

For remote current and contactor control. Receiver plugs directly into the 14-pin receptacle of Miller machine. 90-foot (27.4 m) operating range.



RFCS-14 HD Wired Foot Control 301589

Heavy-duty foot pedal current and contactor control provides increased stability and durability from larger base and heavier cord. Includes 20-foot (6 m) cord with plug.



Running Gear/Cylinder Rack 301239

Heavy-duty construction with 8-inch rubber rear wheels. Convenient front handles, cable holders and plastic consumable box. For gas cylinders no greater than 7 inches (178 mm) in diameter or 65 pounds (29.5 kg) in weight.



Dual Cylinder Rack Conversion Kit and Tool Holder 301454

Converts running gear/cylinder rack (301239) from a single cylinder cart to a dual cylinder cart. Top bracket holds a variety of tools including a welder, adjustable wrench, screwdrivers, chipping hammer, wire brush and filler rod.



Protective Cover 301737

Consumables

For MDX™-100 MIG Gun (15 ft.)

Miller® MDX MIG Gun Consumables

Smaller consumables and components to access hard-to-reach weldments.

Contact Tips (10 per package)

T-M023 .023 in. (0.6 mm)
T-M030 .030 in. (0.8 mm)
T-M035 .035 in. (0.9 mm)
T-M045 .045 in. (1.2 mm)

Nozzles

NS-M1200B Brass, 1/2 in. ID, flush
NS-M1200C Copper, 1/2 in. ID, flush
NS-MFLX Gasless nozzle

Diffuser D-M100

Monocoil Replacement Liners (15 ft.)

LM1A-15 .023/.025 in. (0.6 mm)
LMD2A-15 .030/.035 in. (0.8/0.9 mm)
LMD3A-15 .035/.045 in. (0.9/1.2 mm)

Note: Miller® FasTip™, M-Series and Bernard® Centerfire™ diffusers and consumables are NOT compatible with MDX Series guns.

For Spoolmate™ 100 Spool Gun



Contact Tips (5 per package)

199730 .024 in. (0.6 mm)
186419 .030 in. (0.8 mm)
186406 .035 in. (0.9 mm)



Nozzle 186405

For Spoolmate™ 150 Spool Gun



Contact Tips (5 per package)

199387 .030 in. (0.8 mm)
199388 .035 in. (0.9 mm)

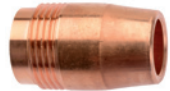

Nozzle 050622

For Both Spool Guns



Drive Roll (1) 186413

For .030/.035-inch (0.8/0.9 mm) wire.



Push Roll (1) 186414

For .030/.035-inch (0.8/0.9 mm) wire.

For Multimatic® 215 PRO



Quick Select™ Drive Roll 261157

For .024-inch (0.6 mm) or .030/.035-inch (0.8/0.9 mm) solid wire, and .030/.035-inch (0.8/0.9 mm) flux-cored wire.

V-Knurled Dual-Groove Drive Roll 202926

For .030/.035-inch (0.8/0.9 mm) or .045-inch (1.2 mm) flux-cored wire.

Ordering Information

EQUIPMENT AND OPTIONS	STOCK NO.	DESCRIPTION	QTY.	PRICE
Multimatic® 215 PRO	907840	120/240 V, 50/60 Hz		
Multimatic® 215 PRO with Welding Cart	951000074	Includes Multimatic® 215 PRO (907840) and running gear/cylinder rack (301239)		
Multimatic® 215 PRO with TIG Contractor Kit	951000213	Includes Multimatic® 215 PRO (907840) and TIG Contractor Kit (301917)		
Guns				
MDX™-100 MIG Gun	1770029	15 ft. (4.6 m), .030–.035 in (0.8–0.9 mm) wire		
Spoolmate™ 100 Spool Gun	300371	12 ft. (3.7 m). Includes custom carrying case		
Spoolmate™ 150 Spool Gun	301272	20 ft. (6.1 m)		
Accessories				
TIG Contractor Kits	301917 301916	With Wireless Foot Pedal With Wired Foot Pedal Kits include 12.5 ft. (3.8 m) Weldcraft™ A-150 TIG torch with flow thru Dinse-style connector, wireless remote foot pedal OR RFCS-14 HD wired foot pedal, flow gauge regulator with 12 ft. (3.7 m) gas hose, and AK2C torch accessory kit		
Weldcraft™ A-150 (WP-17) TIG Torch	WP1712RDI25	12.5 ft. (3.8 m) cable		
TIG Torch Accessory Kit	AK2C	Includes one short back cap, one of each size (#4, #5, # 6) alumina nozzle, and one of each size (.040, 1/16, 3/32 inch) of the following: collet, collet body, and 7-inch 2% ceriated tungsten electrode		
Running Gear/Cylinder Rack	301239			
Dual Cylinder Rack Conversion Kit and Tool Holder	301454			
Dual Cylinder Rack Cart	951770	Includes running gear/cylinder rack (301239) and dual cylinder rack conversion kit (301454). Must be assembled together		
Protective Cover	301737			
Material Thickness Gauge	229895			
NEMA 20 MVP™ Plug	219259	120 V, 20 A plug		
Flow Gauge Regulator and Gas Hose for Argon or AR/CO ₂ Mix	31-50-580-6	Replacement standard regulator and gas hose		
Flow Gauge Regulator for CO ₂	31-50-320	Required if using 100 percent CO ₂ gas		
Flux-cored Wire				
Solid Wire				
Shielding Gas Cylinder				
Helmet/Gloves/Scratch Brush				
Remote Controls				
Wireless Remote Foot Control	301580	Foot control with wireless 90 ft. (27.4 m) operating range		
RFCS-14 HD Wired Foot Control	301589	Heavy-duty foot control		
Consumables				
Contact Tips		See page 7		
Nozzles		See page 7		
Diffuser		See page 7		
Monocoil Replacement Liners		See page 7		
Drive Rolls		See page 7		

DATE :

TOTAL QUOTED PRICE :

Distributed by:

